

GAS FRONT LOAD DRYER

8.0 Cu. Ft.

EFDG317TIW

With IQ-Touch™ Controls



PRODUCT DIMENSIONS

Height	38"
Width	27"
Depth	31-1/2"

MORE EASY-TO-USE FEATURES

5 CYCLES TO CARE FOR EVERY FABRIC

Perfectly dry every item with tailored cycles for towels, delicates, and more.

FITS MORE ROOMS WITH REVERSIBLE DOOR

Enjoy easy loading no matter how your washer and dryer are configured.

OPTIONAL PEDESTALS AND STACKING KIT FOR MORE INSTALLATION OPTIONS

Raise your units with optional pedestal drawers that provide extra storage. Or use the optional stacking kit for convenient placement in small spaces.

Available in:



Island White
(IW)

¹Based on manufacturer specifications among common 27" platforms.

SIGNATURE FEATURES



KEEPS CLOTHES LOOKING THEIR BEST

Clothes are gently tumbled while moisture sensors detect when clothes are dry to prevent over-drying. Customizable options and cycles allow you to care for every fabric.



ENERGY STAR® CERTIFIED

Rigorously tested to do more with less. Electrolux dryers meet strict criteria to guarantee high-quality energy efficient performance.

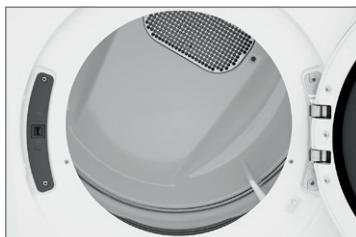

LARGEST CAPACITY DRYER

Dry more in each load. Our 8.0 cu.ft. dryers have the largest capacity for a standard 27" platform.¹

GAS FRONT LOAD DRYER

EFDG317TIW



27" GAS FRONT LOAD DRYER

Capacity D.O.E.	8.0 Cu.Ft.
-----------------	------------

FEATURES

Pull-to-Open Door	Yes
iQ-Touch™ Controls	Yes
Perfect Steam™ Dry System	
Dry System	Luxury-Dry™
Sound System	Luxury-Quiet™
Lighting	
Tumble System	Gentle Tumble™
Moisture Sensor	Yes
Dryer Drum	Painted Steel
Tumble Speed (RPM)	50
Reversible Door	Yes
Adjustable Leveling Legs	Yes
ENERGY STAR®	Yes
NSF® Certified	

CYCLES

Timed Dry (Auto, 60, 30), Heavy Duty, Towels, Normal, Delicates	5
---	---

OPTIONS

Temperature Selections	3
Add Steam	
Electronic Auto Dry System	
Manual Timed Dry Selections	3
Eco	Yes
End-of-Cycle Chime	On/Off
Extended Tumble	
Anti-Static	
Line Dry	
Wrinkle Release	Yes
Dryness Levels	3

INSTALLATION OPTIONS

Freestanding, Under Counter*, Stacked (Above Washer), Pedestal, Hidden (In Closet), Second Floor	Yes
4-Way Dryer Venting	Yes

ACCESSORIES

Luxury-Glide® Pedestal with Spacious Storage Drawer – Island White – PN# EPWD157SIW	Optional
LP Gas Conversion Kit – PN# PCK4200	Optional
Dryer Stacking Kit – PN# STACKIT7X	Optional
Drying Rack – PN# A04840701	Optional

SPECIFICATIONS

Color –	
Island White	IW
Maximum Exhaust Duct Length** (FT.)	125
Gas/Power Supply Connection Location	Centerline Lower Rear / Rear
Voltage Rating	120V / 60 Hz
Connected Load (kW Rating) @ 120 Volts [‡]	0.835
Amps @ 120 Volts	9.0
Heating Element (BTU / HR)	20,000
Shipping Weight (Approx.)	140 Lbs.

*Side-by-Side units in under-counter installation require custom-built countertop and/or cabinetry.

**Rigid metal duct preferred, semi-rigid optional and allow deductions for elbows and vents. Refer to Installation Guide on web for additional information.

‡An electrical supply with grounded three-prong receptacle is required. The power supply circuit must be installed in accordance with current edition of National Electrical Code (NFPA 70) and local codes & ordinances.

NOTE: Always consult local and national electric, gas and plumbing codes. Refer to Product Installation Guide for detailed installation instructions on the web at electroluxappliances.com.

Specifications subject to change.

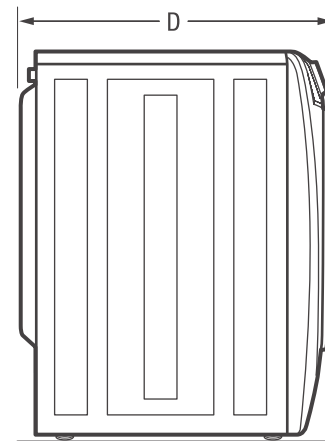
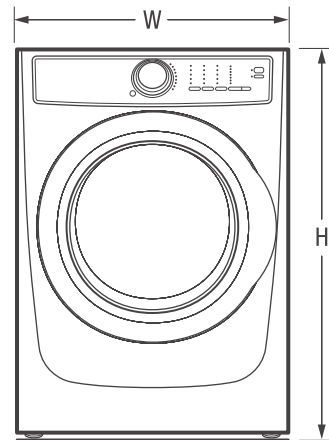

PRODUCT DIMENSIONS

Height (without 15" Pedestal)	38"
(with 15" Pedestal)	53-1/4"
Width	27"
Depth (to Center of Arc Not Including Hose)	31-1/2"
(with Door 90° Open)	50-5/8"

Electrolux Major Appliances, N.A.

USA • 10200 David Taylor Drive • Charlotte, NC 28262 • 1-877-4electrolux (1-877-435-3287) • electroluxappliances.com
 CANADA • 5855 Terry Fox Way • Mississauga, ON L5V 3E4 • 1-800-265-8352 • electroluxappliances.ca

EFDG317T 03/17

© 2017 Electrolux Home Products, Inc.



High standards of quality at Electrolux Home Products, Inc. mean we are constantly working to improve our products. We reserve the right to change specifications or discontinue models without notice.

GAS FRONT LOAD DRYER

EFDG317TIW

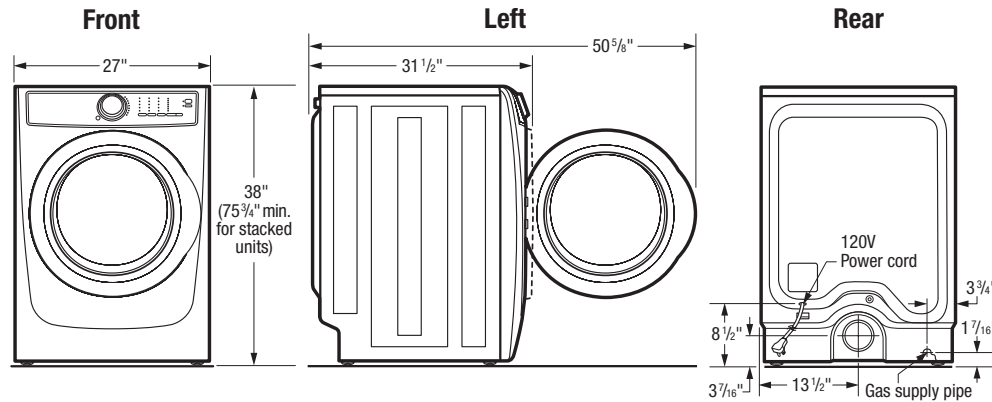

15" Pedestal Drawer Installation

Elevates dryer height to 53 1/4". For detailed pedestal installation, refer to instructions included with pedestal or on web. Pedestal Installation may require modified utility hookup locations. For details, refer to Product Installation Guide on web.

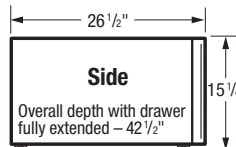
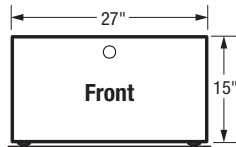

Built-In Installations

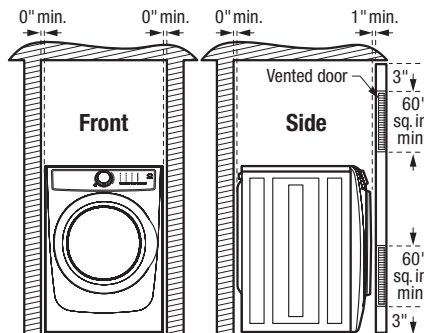

Closet Installation:

If washer and dryer are installed in same closet, door(s) MUST be vented with 120 sq. in. minimum louvered opening, equally divided, located 3" from top and bottom of door. Louvered door(s) with equivalent air openings for full-length of door is acceptable. Air openings MUST remain unobstructed with door(s) installed.

Installation Clearances:

Dryer can be built in alone or with washer (side by side or stacked) in closet, recess or under counter installation with 0" minimum clearance required around sides and back of unit(s). To achieve 0" minimum rear clearance, dryer MUST be vented straight back or with quick-turn 90° elbow. Installation of closet door(s) requires additional 1" minimum clearance between front of unit(s) and door(s). Location of plumbing, exhaust and utility hookups MUST be considered when planning any built-in installation. For additional installation details, refer to Product Installation Guides on web.

Under Counter Installation:

Installation of dryer alone or side by side with washer under counter, requires custom-built countertop and/or cabinetry to accommodate unit(s) height.

Stacking Units:

Stacking dryer above washer requires use of optional Stacking Kit (PN# STACKIT7X) with modified utility hookup locations for dryer. For complete installation details, refer to instructions included with Stacking Kit or on web.

Gas Dryer Specifications

- Product Weight – 130 Lbs. / Shipping Weight – 140 Lbs.
- An electrical supply with grounded three-prong receptacle is required. The power supply circuit must be installed in accordance with current edition of National Electrical Code (ANSI/NFPA 70) and local codes & ordinances. (Do not use same circuit as washer.)
- Voltage Rating – 120V/60 Hz
- Connected Load (kW Rating) @ 120 Volts = 0.835 kW
- Amps @ 120V = 9A
- Equipped with 120V 3-wire power supply cord, approx. 60" long.
- Always consult local and national electric, gas & plumbing codes.
- Can be installed alone, with or without optional 15" pedestal drawer, or stacked above matching Electrolux Washer, which requires installation of optional dryer stacking kit. (For installation details, refer to instructions included with optional pedestal or stacking kit or on web.)
- Can be built in alone or with matching Electrolux Washer (side by side or stacked) in closet, recess or under counter installation with 0" minimum clearance required around sides and back of unit(s). To achieve 0" minimum rear clearance, dryer MUST be vented straight back or with quick-turn 90° elbow. Installation of closet door(s) requires additional 1" minimum clearance between front of unit(s) and door(s). Location of plumbing, exhaust and utility hookups MUST be considered when planning any built-in installation.
- Under-counter installation requires custom-built countertop and/or cabinetry to accommodate unit(s) height.
- Do NOT install in area exposed to dripping water or outdoor weather conditions, or where gasoline or other flammables, including automobiles, are kept or stored.
- For garage installation, dryer MUST be located minimum 18" above floor.

- Floor MUST be solid with 1" maximum slope. To ensure vibration or movement does not occur, reinforcement of floor may be necessary. Do NOT install on carpeted surface.
- Dryer MUST exhaust to outside of building, NOT into any concealed space.
- Dryer equipped for 4-way venting and approved for up to 125-foot-equivalent of duct length, determined by length of run and number of elbows needed.
- Exhaust installation requires minimum 4"-diameter rigid or semi-rigid metal duct with approved, unobstructed vent hood having swing-out damper(s). If installing rigid metal duct (preferred), do not exceed MAXIMUM venting run length of 125 ft., allow deductions for elbows and vents. If installing semi-rigid metal duct, do not exceed MAXIMUM venting run length of 8 ft., always allow deductions for elbows and vents (Refer to Product Installation Guide on web for additional information). Do NOT use flexible plastic or metal foil duct and use shortest run possible.
- Gas supply line should be 1/2" pipe and MUST have individual shutoff valve.
- Leveling legs supplied to level dryer properly and reduce excessive noise and vibration.

Note: For planning purposes only. Refer to Product Installation Guide on the web at electroluxappliances.com for detailed instructions.

Optional Accessories

- Pedestal Drawers – Island White (PN# EPWD157SIW).
- Dryer Stacking Kit – (PN# STACKIT7X).
- LP Gas Conversion Kit – (PN # PCK4200).
- Drying Rack – (PN # A04840701).

Electrolux Major Appliances, N.A.

USA • 10200 David Taylor Drive • Charlotte, NC 28262 • 1-877-4electrolux (1-877-435-3287) • electroluxappliances.com
 CANADA • 5855 Terry Fox Way • Mississauga, ON L5V 3E4 • 1-800-265-8352 • electroluxappliances.ca

EFDG317T 03/17

© 2017 Electrolux Home Products, Inc.



High standards of quality at Electrolux Home Products, Inc. mean we are constantly working to improve our products. We reserve the right to change specifications or discontinue models without notice.